

5N65G

5 Amps, 650 Volts N-CHANNEL Power MOSFET

FEATURE

- 5A, 650V, $R_{DS(ON)MAX}=2.8\ \Omega$ @ $V_{GS}=10V/2A$
- Low gate charge
- Low C_{iss}
- Fast switching
- 100% avalanche tested
- Improved dv/dt capability

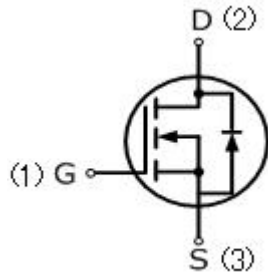

TO-252-2L

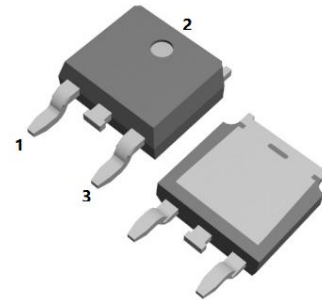

Absolute Maximum Ratings ($T_C=25^\circ\text{C}$, unless otherwise noted)

Parameter	Symbol	5N65G	UNIT
Drain-Source Voltage	V_{DSS}	650	V
Gate-Source Voltage	V_{GS}	± 30	
Continuous Drain Current	I_D	5	A
Pulsed Drain Current (Note 1)	I_{DM}	20	
Single Pulse Avalanche Energy (Note 2)	E_{AS}	150	mJ
Reverse Diode dV/dt (Note 3)	dv/dt	5	V/ns
Operating Junction and Storage Temperature Range	T_J, T_{STG}	-55to+150	$^\circ\text{C}$
Maximum lead temperature for soldering purposes, 1/8" from case for 5 seconds	T_L	260	$^\circ\text{C}$

Parameter	Symbol	5N65G	Units
Thermal resistance, Channel to Case	$R_{th(ch-c)}$	1.67	$^\circ\text{C}/\text{W}$
Maximum Power Dissipation	$T_C=25^\circ\text{C}$ P_D	75	W

Electrical Characteristics ($T_c=25^{\circ}\text{C}$, unless otherwise noted)						
Parameter	Symbol	Test Conditions	Min	Typ	Max	Units
Off Characteristics						
Drain-Source Breakdown Voltage	BV_{DSS}	$V_{GS}=0V, I_D=250\mu A$	650	—	—	V
Zero Gate Voltage Drain Current	I_{DSS}	$V_{DS}=650V, V_{GS}=0V$	—	—	1	μA
Gate-Body Leakage Current, Forward	I_{GSSF}	$V_{GS}=30V, V_{DS}=0V$	—	—	100	nA
Gate-Body Leakage Current, Reverse	I_{GSSR}	$V_{GS}=-30V, V_{DS}=0V$	—	—	-100	nA
On Characteristics						
Gate-Source Threshold Voltage	$V_{GS(th)}$	$V_{DS}=V_{GS}, I_D=250\mu A$	2.0	—	4.0	V
Drain-Source On-State Resistance	$R_{DS(on)}$	$V_{GS}=10V, I_D=2A$	—	2.3	2.8	Ω
Dynamic Characteristics						
Input Capacitance	C_{iss}	$V_{DS}=25V, V_{GS}=0V,$ $f=1.0\text{MHZ}$	—	628	—	pF
Output Capacitance	C_{oss}		—	48	—	pF
Reverse Transfer Capacitance	C_{rss}		—	22	—	pF
Switching Characteristics						
Turn-On Delay Time	$t_{d(on)}$	$V_{DD}=325V, I_D=5A,$ $R_G=10\Omega$	—	11.8	—	ns
Turn-On Rise Time	t_r		—	1.2	—	ns
Turn-Off Delay Time	$t_{d(off)}$		—	21.2	—	ns
Turn-Off Fall Time	t_f		—	5.8	—	ns
Total Gate Charge	Q_g	$V_{DS}=520V, I_D=5A,$ $V_{GS}=10V$	—	13	—	nC
Gate-Source Charge	Q_{gs}		—	6.7	—	nC
Gate-Drain Charge	Q_{gd}		—	2	—	nC
Drain-Source Body Diode Characteristics and Maximum Ratings						
Diode Forward Voltage	V_{SD}	$I_S=6A, V_{GS}=0V$	—	—	1.2	V
Reverse Recovery Time	t_{rr}	$V_{DS}=30V, I_S=1A,$ $dI_F/dt=100A/\mu s, (\text{Note3})$	—	149	—	ns
Reverse Recovery Charge	Q_{rr}		—	372	—	nC

Notes

1. Repetitive Rating: pulse width limited by maximum junction temperature.
2. $V_{DD}=50V, L=10\text{mH}, R_g=25\Omega$, starting $T_J=25^{\circ}\text{C}$.
3. Pulse width $\leq 300\mu s$; duty cycle $\leq 2\%$.

RATING AND CHARACTERISTIC CURVES



Peak Diode Recovery dv/dt Test Circuit



Peak Diode Recovery dv/dt Waveforms



Switching Test Circuit



Switching Waveforms



Gate Charge Test Circuit



Gate Charge Waveform



Unclamped Inductive Switching Test Circuit

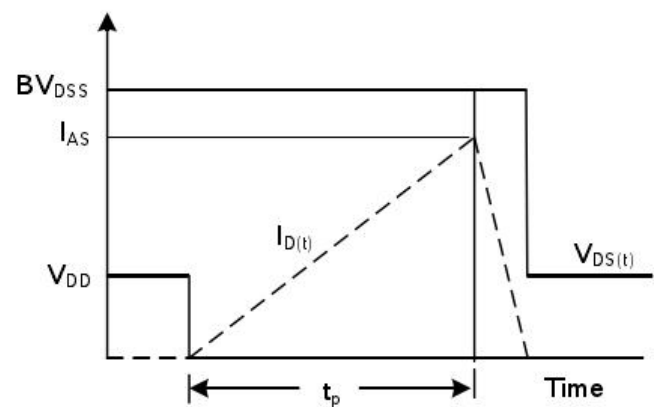

Unclamped Inductive Switching Waveforms

RATING AND CHARACTERISTIC CURVES

Figure.1 Typical Output Characteristics

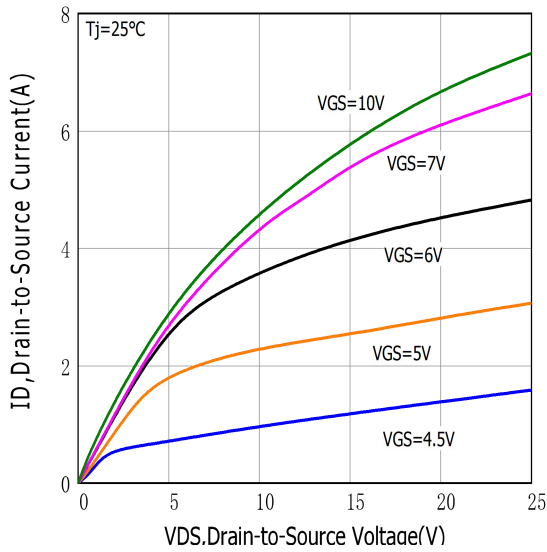

Figure.2 Typical Gate Charge vs Gate to Source Voltage

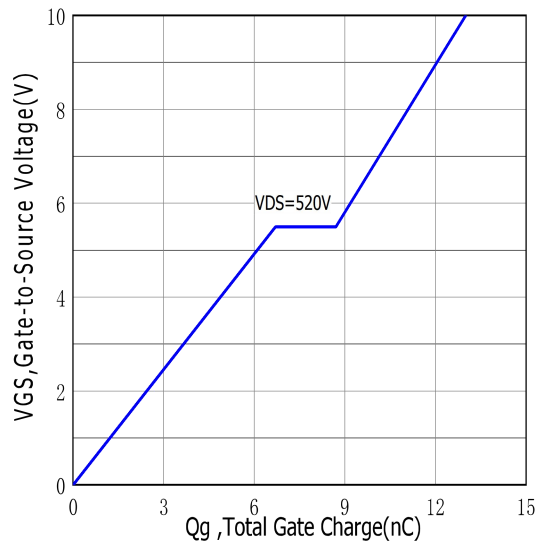

Figure.3 Typical Body Diode Transfer Characteristics

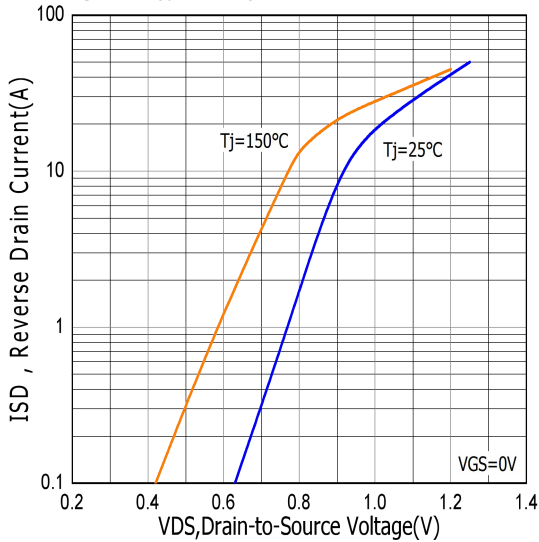

Figure.4 Typical Capacitance vs Drain to Source Voltage

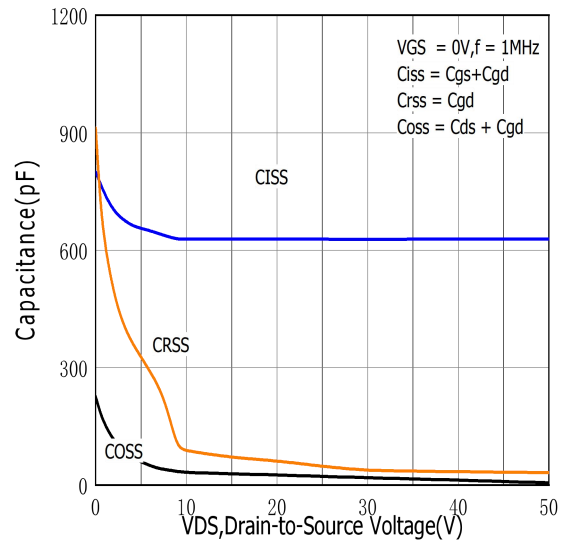

Figure.5 Typical Breakdown Voltage vs Junction Temperature

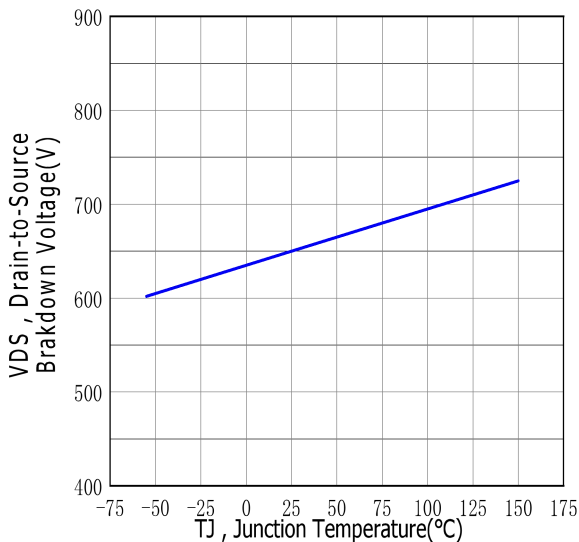

Figure.6 Typical Drain to Source on Resistance vs Junction Temperature

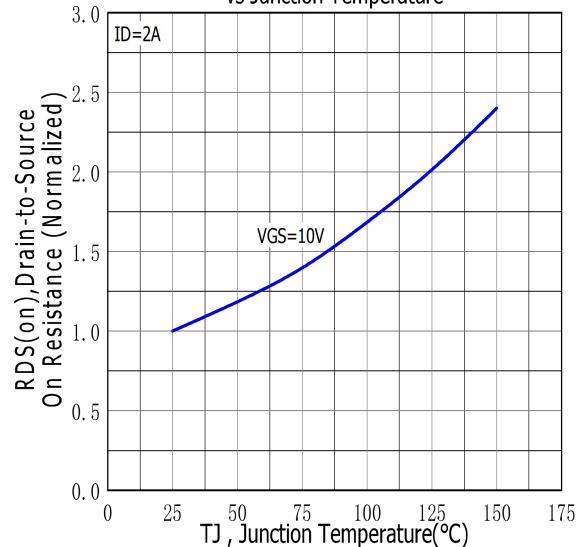

Figure.7 Maximum Forward Bias Safe Operating Area

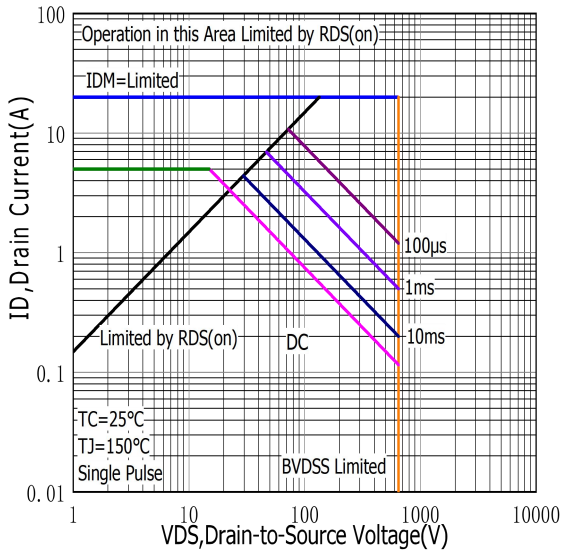

Figure.8 Typical Drain to Source ON Resistance vs Drain Current

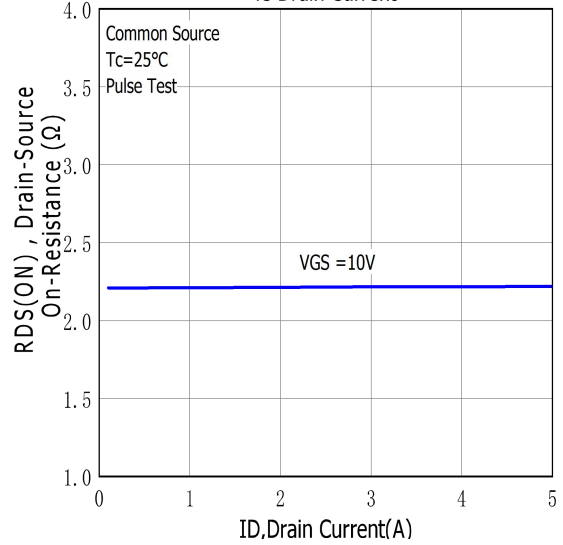

Figure.9 Maximum EAS vs Channel Temperature

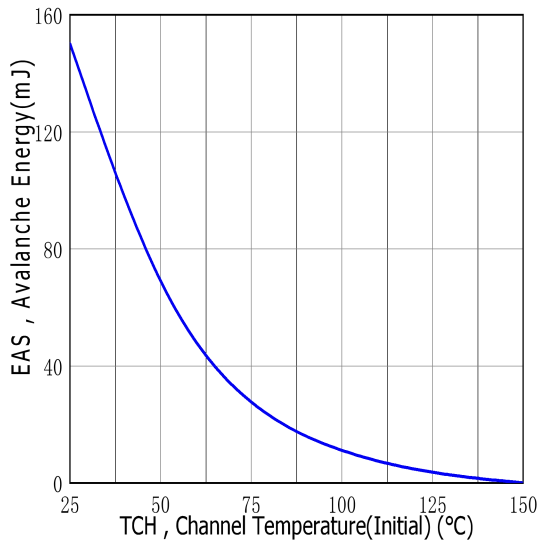

Figure.10 Typical Threshold Voltage vs Case Temperature

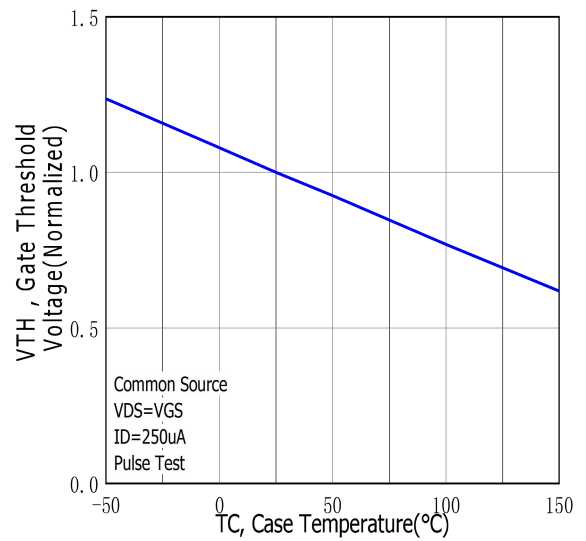

Figure.11 Maximum Effective Thermal Impedance, Junction to Case

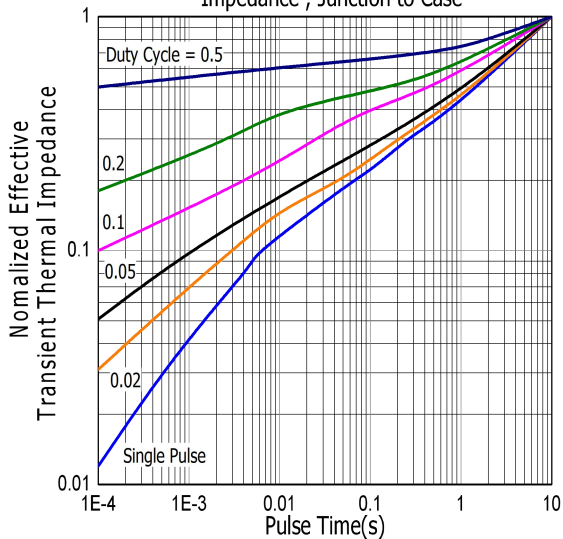
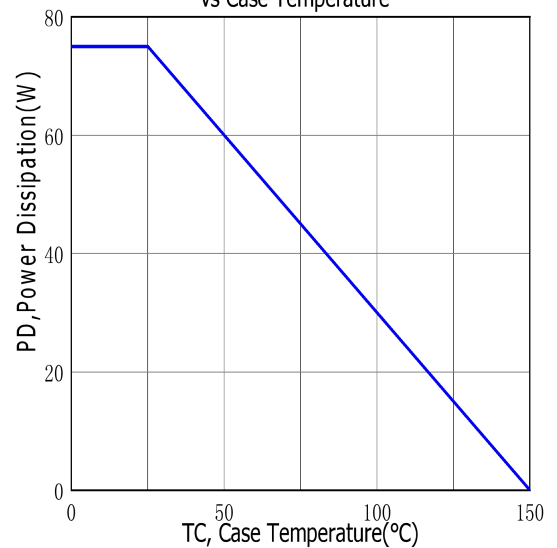
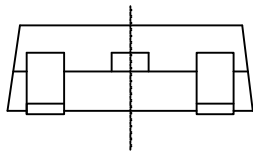
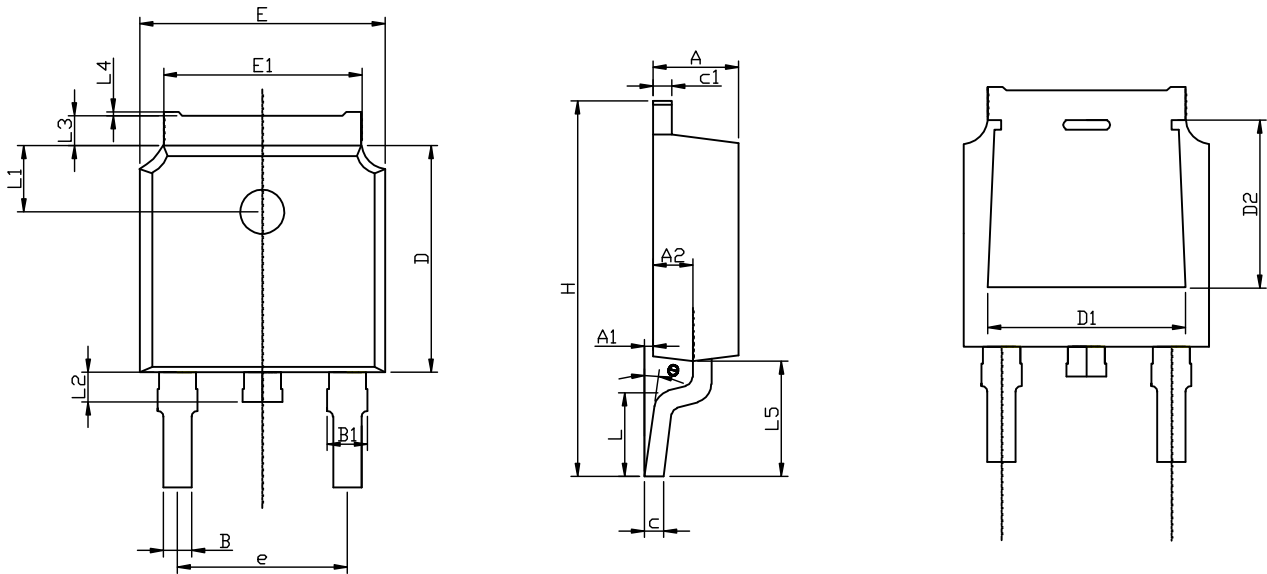

Figure.12 Maximum Power Dissipation vs Case Temperature



TO-252-2L PACKAGE OUTLINE



RECOMMENDED LAND PATTERN

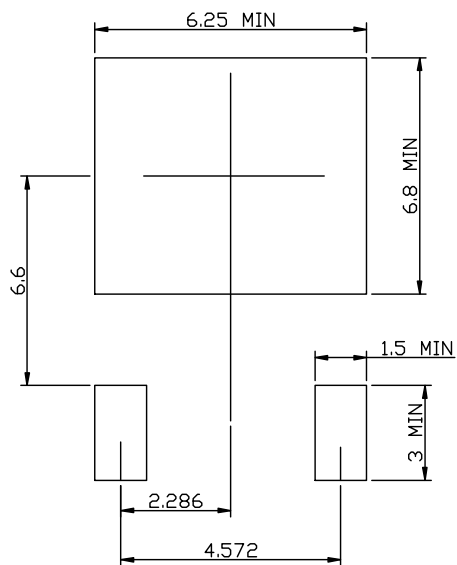

	MIN	NOM	MAX
A	2.15	2.30	2.45
A1	0.05	0.10	0.20
A2	0.91	1.07	1.22
B	0.66	0.76	0.86
B1	0.93	1.08	1.23
C	0.40	0.50	0.60
C1	0.40	0.50	0.60
D	5.95	6.10	6.25
D1	-	4.8REF	-
D2	-	3.8REF	-
E	6.45	6.60	6.75
E1	5.12	5.32	5.52
L		1.65	
L1	1.58	1.78	1.98
L2	0.60	0.80	1.00
L3	0.70	0.85	1.00
L4	0.00	0.05	0.20
L5	2.80	3.10	3.40
H	9.80	10.10	10.40
Θ	0°		8°
e		4.572REF	

UNIT: mm